

**SCP 084-130 DIN Agri is a series of piston pumps with a fixed displacement for demanding mobile hydraulics.**

SCP 084-130 DIN Agri covers the displacement range 5.10-7.93 cu in/rev at a maximum working pressure up to 5800 psi. It is a modern, compact pump which meets the market's high demands on flow performance, pressure, efficiency and small installation dimensions.

It is suitable for agricultural applications with tractor PTO drive.

**Other advantages:**

- High maximum speed while maintaining low noise levels
- Smooth operation over the entire speed range
- Long life due to high demands on material selection, such as bearings, seals, etc
- O-rings on all contact surfaces as well as double shaft seals eliminate oil leakage

## Versions, main data

SC	P	-	084	L	-	N	-	DL4	-	AZ6	-	S0	S	-	0	00
Line	1		2	3		4		5		6		7	8		9	10

Line	
SC	Sunfab Compact, bent-axis design

1. Type	
P	Pump

2. Displacement			
084	090	108	130

3. Direction of rotation	
R	Right
L	Left

4. Shaft seal	
N	Nitrile

5. Mounting flange	
DL4	DIN 4-h (ISO 7653D)

6. Shaft	
AZ6	S5ISO 5003:2014

7. Connection cover	
S0	40° Sunfab standard

8. Connections	
S	Sunfab standard

9. Additional	
0	-

10. Accessories	
00	No accessories available

SCP 084-130 DIN Agri		084	090	108	130
<b>Theoretical oil flow l/min at pump speed</b>					
rpm	500	42	45	54	65
	1000	84	90	108	130
	1500	125	135	162	195
<b>Displacement</b>					
cu in/rev		5.10	5.49	6.59	7.93
<b>Max pump speed</b>					
<i>continuous</i>	rpm	1500	1500	1500	1500
<i>intermittent</i>		2000	2000	2000	2000
<b>Max working pressure</b>					
psi		5800	4350	5800	4350
<b>Weight</b>					
lb		38.0	26.5	38.0	38.6
<b>Tare-weight torque (M)</b>					
lb-ft		15.4	9.6	15.4	15.4
<b>Direction of rotation</b>					
Left (L) or Right (R)					

# Dimensions SCP 084/108-130 DL4 AZ6

Millimeter (inch)

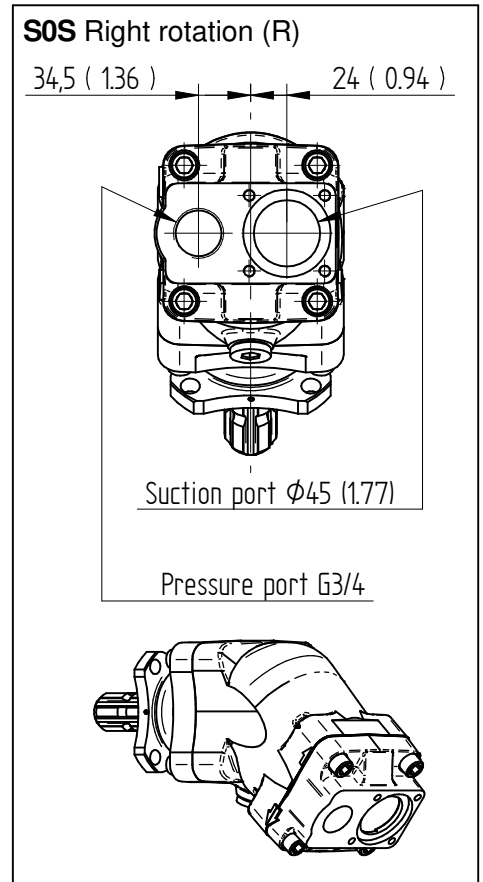
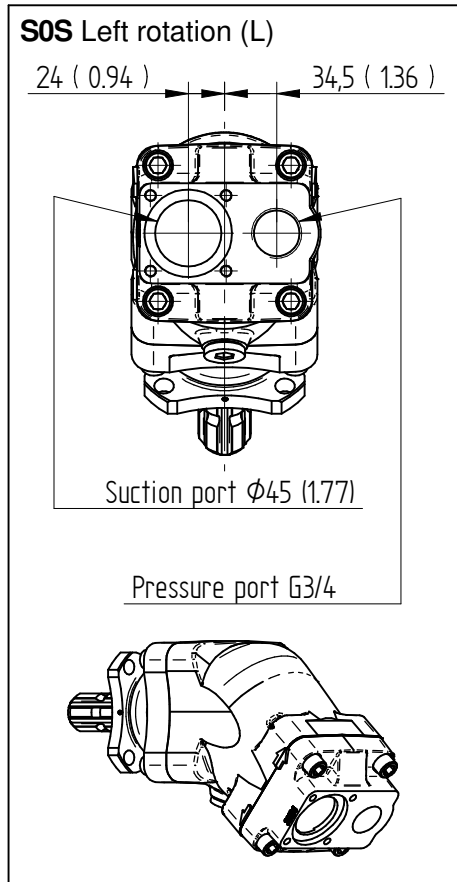
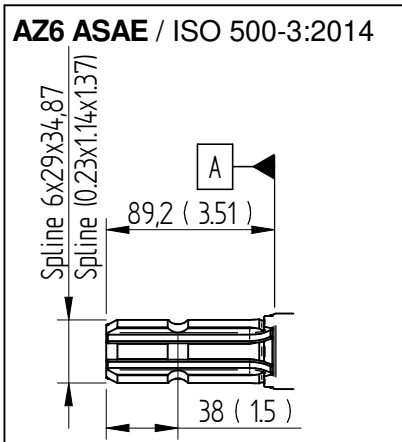
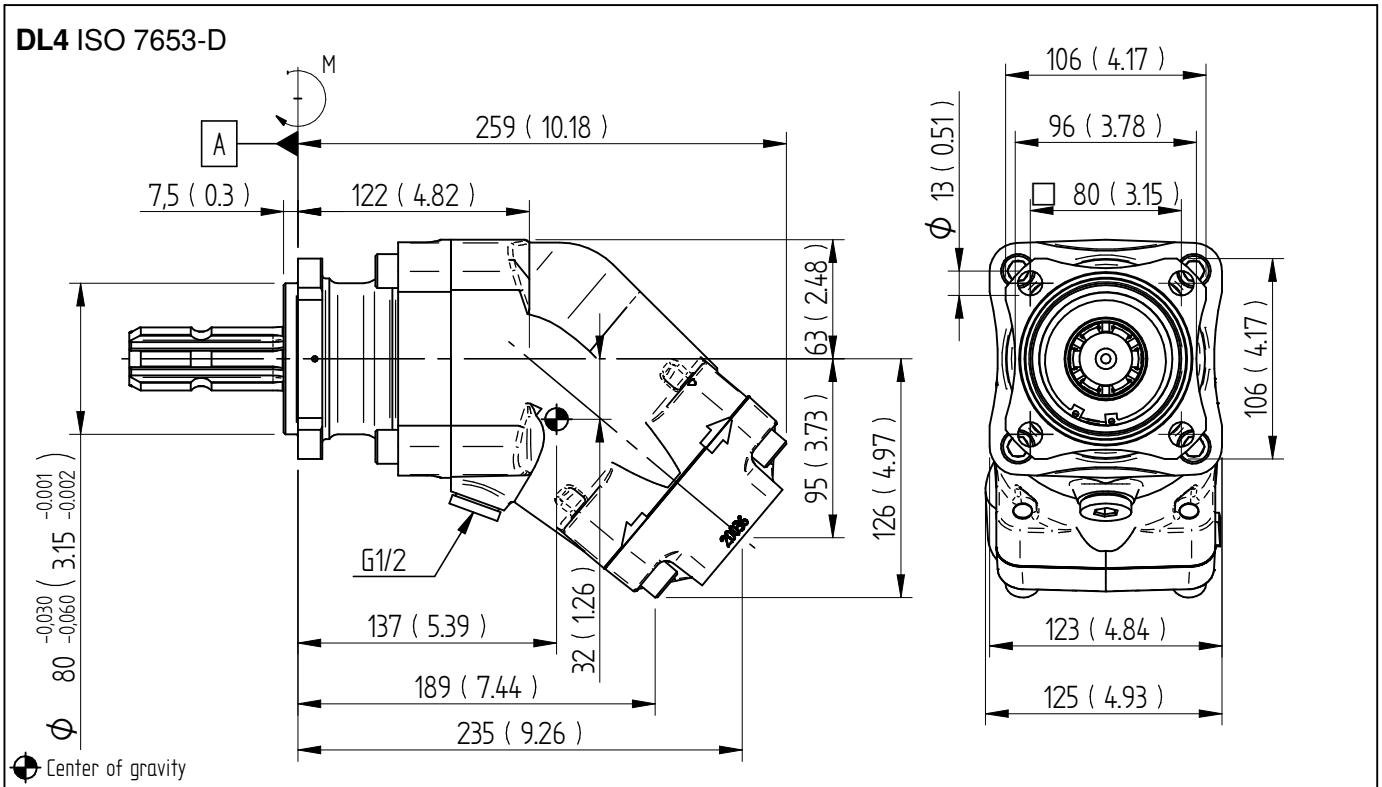

# Dimensions SCP 090 DL4 AZ6

Millimeter (inch)

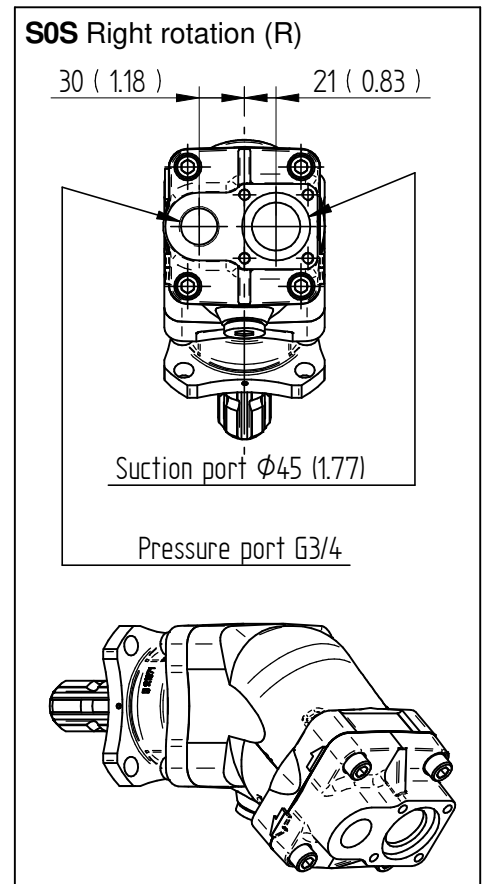
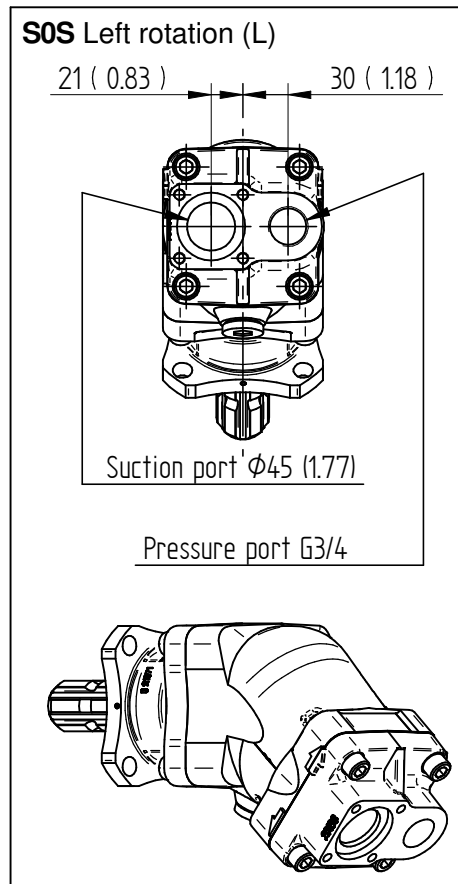
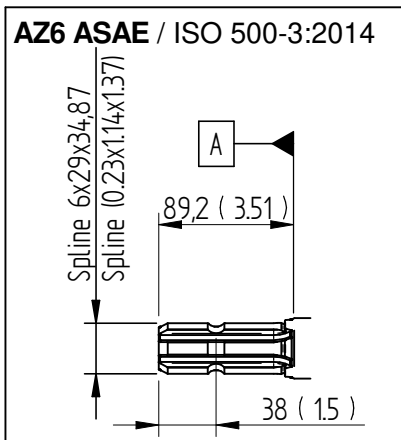
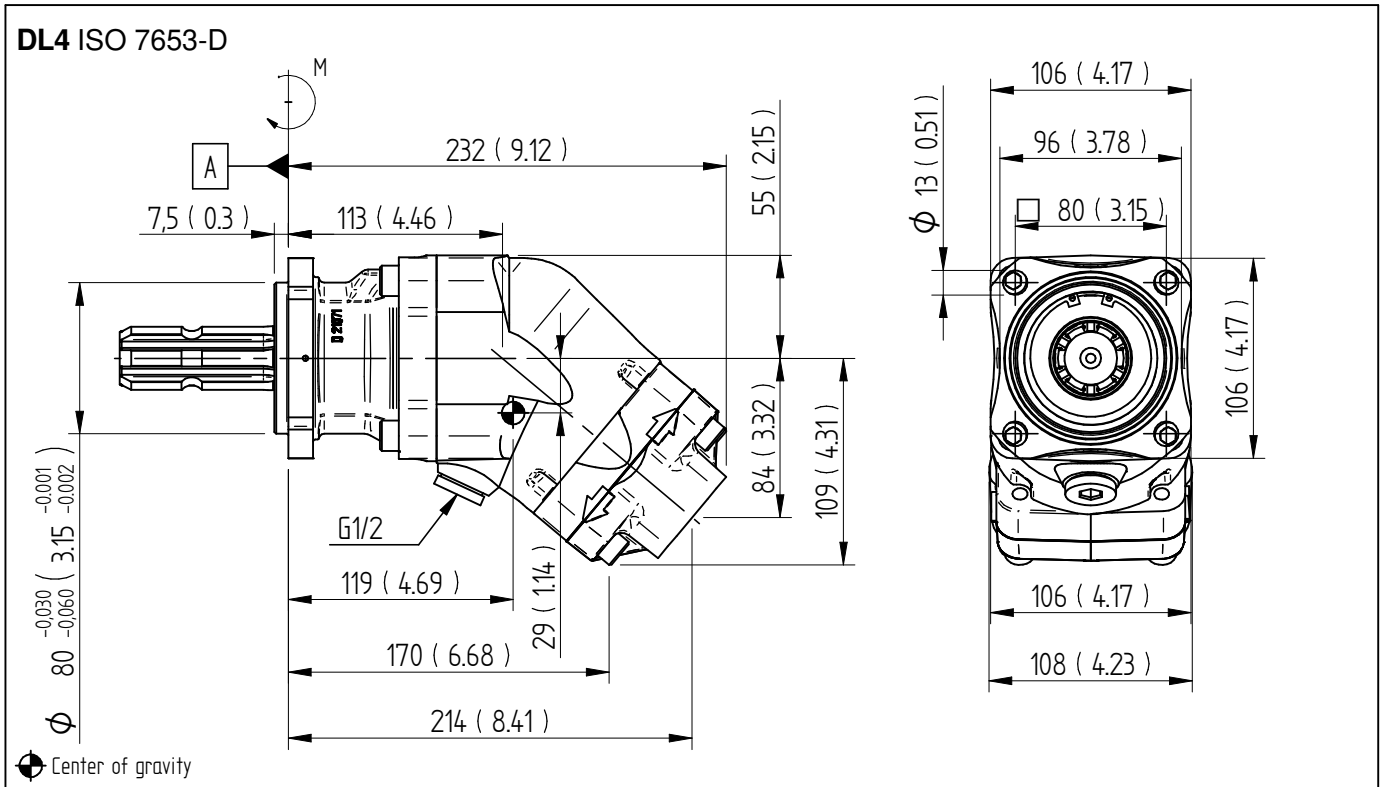



**WARNING!**

When the pump is running:

1. Do not touch the pressure hose
2. Watch out for rotating parts
3. The pump and hoses may be hot

Sunfab reserves the right to make changes in design and dimensions without notice. Printing and typesetting errors reserved.

© Copyright 2024 Sunfab Hydraulics AB. All Rights Reserved.